

## Plasma cutter SPARTUS® ProCUT



**45PFC**



**User's manual**



## WELDING EQUIPMENT SUITABLE FOR TODAY'S NEEDS

### **Thank you for purchasing our product!**

You have made a right choice. Plasma welding and welding processes are carried out in difficult conditions that expose welding equipment to extreme tests of its strength. Only high quality equipment can ensure required reliability and performance during realization of the above-mentioned processes. SPARTUS® products are characterized by precisely such features: they are primarily reliable and durable, but they are also versatile. We listen carefully to clients' needs. Therefore, our offer covers such a wide assortment of products. Thank you very much for your trust in our company. We would like to invite you to familiarize yourself with the remaining products and offer at [www.spartus.info](http://www.spartus.info) or directly at a local distributor of SPARTUS® products.

# TABLE OF CONTENTS

1. SAFE USE – HAZARDS ASSOCIATED WITH ARC WELDING AND PLASMA CUTTING .....	2
1.1 General safety rules .....	2
1.2 Electric shock can kill .....	2
1.3 Welding arc radiation can be dangerous .....	3
1.4 Vapours and gases can be dangerous .....	3
1.5 Noise can be harmful .....	4
1.6 Fire or explosion hazard .....	5
1.7 Other hazards .....	6
1.8 Other informations .....	6
1.9 Symbols used in instructions .....	7
2. ELECTROMAGNETIC FIELD (EMF) .....	7
3. ELECTROMAGNETIC COMPATIBILITY (EMC) .....	7
3.1 General informations .....	7
3.2 Assesment of area .....	8
3.3 Methods of reducing emmissions .....	8
4. CONFORMITY WITH STANDARDS .....	8
4.1 CE marking .....	9
4.2 Rating plate .....	9
5. GENERAL DESCRIPTION .....	9
5.1 Purpose of use .....	9
6. TECHNICAL SPECIFICATIONS .....	9
6.1 Operation, storage and transport .....	9
6.2 Technical parameters of device .....	10
7. INSTALLATION AND USE .....	10
7.1 Proper cooling .....	11
7.2 Movement and handling .....	11
7.3 Description of construction .....	11
7.4 Connecting to power supply .....	12
7.5 Device connection .....	12
7.6 Control panel .....	13
7.7 Central connector – setup of pins .....	15
7.8 CNC connector .....	16
7.9 The process of cutting .....	16
7.10 The table below for the shift and scale selection .....	16
7.11 Recommended SPARTUS® SP45H plasma torch .....	18
8. MAINTENANCE .....	19
9. ENVIRONMENTAL PROTECTION .....	19
10. TROUBLESHOOTING .....	20



## IMPORTANT!

*Before using this product, read the instruction manual in its entirety, with understanding. Keep the instructions for quick reference to it if necessary. Pay special attention to safety instructions provided for your protection. In the event of any points of misunderstanding instructions, contact your supplier or supervisor.*

# 1. SAFE USE – HAZARDS ASSOCIATED WITH ARC WELDING AND PLASMA CUTTING

Arc welding and plasma cutting are processes that can pose hazards for the operator and persons in his vicinity. The operator and his close surroundings are exposed, among others, to the risk of fire, explosion, electric shock, burning, as well as the risk of getting injured by moving parts of the device.

Once proper safety measures are provided, electric welding and plasma cutting are relatively safe processes. For this reason, it is crucial to strictly follow the valid OSH principles during welding operations.

The informations provided below do not release the operator from the obligation to follow the OSH rules that are binding in his plant/workplace.

## 1.1 GENERAL SAFETY RULES

Welding operators and persons working in the vicinity of the welding process should be made aware of the following hazards associated with arc welding. They should be made aware of protective measures as specified in relevant international and national standards and regulations.

### 1.1.1 Equipment condition and maintenance

- Check the technical condition of the device and accessories before starting to weld/plasma cutting. It is forbidden to use equipment that is unserviceable.
- Equipment damaged or defective should be immediately repaired or removed from service.

### 1.1.2 Operation and carrying

- Apply appropriate protective measures in the space around the zone, where welding operations are expected to be carried out.
- All equipment should be placed so that it does not present a hazard in passageways, on ladders or stairways, etc.
- Falling objects can cause injuries or kill. Protect device before accidentally falling.
- Welding equipment may be heavy (e.g. *wire*

*feeder fitted with spool and harness*). Care shall be taken during manual handling.

- To handle heavy elements, use hoists/trucks/transport equipment designed especially for this purpose. Make sure the weight of equipment to be handled does not exceed the admissible maximum lifting capacity of used hoist/truck/transport equipment.
- It is forbidden for unauthorized persons, especially children, to be in the vicinity of the device during its use.
- The device is not suitable for pipe defrosting.
- Device use non-compliant with its intended purpose is forbidden.

### 1.1.3 Training

- Only professionally trained and qualified personnel may install, operate, maintain and repair the device.
- For operators and their supervisors training is essential in: the safe use of the equipment; the processes; the emergency procedures.

## 1.2 ELECTRIC SHOCK CAN KILL



- Before starting to weld and during the welding process, the operator should insulate himself from the ground and the environment by means of dry and undamaged protective clothes. It is forbidden to work on wet ground.
- It is forbidden to touch SK sockets („+“ and/or „-“) when the device is in operation (*connected to a power supply source*).
- It is forbidden to touch live electric components of the device.

- Power supply must never be connected before the accessories of SK sockets/connectors are properly installed in the device.
- Use dry and undamaged welding gloves and protective clothing, in order to ensure proper insulation of the body. It is forbidden to touch with a bare hand any elements that are parts of an electric circuit.
- The operator must always make sure that there is a good electric connection of the return conductor to the element to be welded. The connection should be located as close to the welding zone as possible.
- Maintain the electrode grip, the welding torch, the chassis ground clamp, welding cables and the welding machine in proper technical condition that ensures safe operation. Damaged cable insulation should be replaced with new insulation.
- Never dip an electrode into water, to cool it down.
- When working above the floor level (at a height), use a safety harness to protect yourself against falling, in the case of potential electric shock.
- Exercise special caution, when using the device in small rooms or in rooms with elevated humidity levels.

### 1.3 WELDING ARC RADIATION CAN BE DANGEROUS

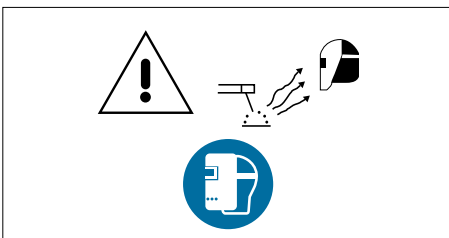

The arc generates:

- ultraviolet radiation (*can damage skin and eyes*);
- visible light (*can dazzle and impair vision*);
- infrared (*heat*) radiation (*can damage skin and eyes*).

Such radiation can be direct or reflected from surfaces such as bright metals and light coloured objects.

#### 1.3.1 Eye and face protection

- Use welder's helmet/shield with an appropriate filter to protect you face and eyes against sparks and welding arc radiation.
- The shield / helmet should provide eye and face protection against injuries that may result in welding spatters.
- Welding helmet/shield should be made in accordance with applicable standards.

#### 1.3.2 Body protection

- The body should be protected by suitable clothing in accordance with applicable standards.
- Use appropriate protective clothing made of durable and fire-resistant material, to ensure proper skin protection.
- The use of neck protection can be necessary against reflected radiation.

#### 1.3.3 Protection of persons in the vicinity of an arc

- Protect the remaining personnel present in the vicinity of welding works against negative impact of arc radiation and welding splatters. Warn them about the hazard resulting from exposure to the welding arc. In the vicinity of an arc, non-reflective curtains or screens should be used to isolate persons from the arc radiation. A warning, e.g. a symbol for eye protection, should refer to the hazard of arc optical radiation. Welder's assistants should also wear appropriate protective clothing.

### 1.4 VAPOURS AND GASES CAN BE DANGEROUS

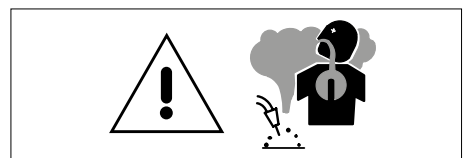

Arc welding and allied processes produce welding fume which may pollute the atmosphere surrounding the work. Welding fume is a varying mixture of airborne gases and fine particles which, if inhaled or swallowed, constitute a health hazard.

The degree of risk is depend on:

- the composition of the fume;
- the concentration of the fume;
- the duration of exposure.

A systematic approach to the assessment of exposure is necessary, taking into account the particular circumstances of the operator and the ancillary worker who can be exposed.

Welding fume may be controlled by a wide range of measures, e.g. process modifications, engineering controls, methods of work, personal protection and administrative action.

First it is necessary to consider whether exposure can be prevented by eliminating the generation of welding fume altogether. Where this cannot be done, measures for reducing the quantity of welding fume generated should be investigated, after which the control of welding fume at source should be considered. The use of respiratory equipment should not be contemplated until all other possibilities have been eliminated. Normally, respiratory protective equipment should be used only as an interim measure. However, there cannot be a situation in which, in addition to ventilation, the use of personal protection is necessary.

#### 1.4.1 VAPOURS AND GASES. ADDITIONAL PRECAUTIONS

- Welding operations can involve generation of vapours and gases that are hazardous to health. Inhaling the vapours should be avoided. Keep your head away from vapours during welding operations. Ensure proper ventilation and/or mechanical welding exhaust draught to keep vapours and gases away from the breathing zone.
- When welding is carried out in a confined space, operators should only be permitted to weld when other persons, who have been instructed and who are able to react

in case of an emergency, are in the immediate vicinity.

- In closed rooms or in certain circumstances during outdoor operations, it may be required to use individual equipment for the protection of the welder's airways, e.g. a respirator. Additional safety measures are also required when galvanized steel is welded.
- Welding operations must not be performed in the vicinity of chlorinated hydrocarbons generated during degreasing, cleaning or spraying. Heat and radiation generated by the arc may enter into a reaction with vapours of solvents, which may lead to the formation of phosgene – a highly toxic gas.
- The shielding gas used during arc welding may force the air out of a room. This may lead to a health hazard or even death. Proper ventilation, especially in closed rooms, should always be provided, to ensure appropriate amount of air that is indispensable for safe breathing.

#### 1.5 NOISE CAN BE HARMFUL



In the welding environment, damaging levels of noise can exist. Continued exposure to a high noise level on the unprotected ear is injurious. The noise levels should be reduced to the lowest practicable level.

High levels may be tolerated for very short periods by wearing adequate ear protection in accordance with the national or local regulation. In case of doubt, checks by an expert should be made to establish noise levels in any particular environment, and, if these are in excess of the prescribed limit, one of the following alternatives may apply:

- a) insulation of the noise source as far as possible, e.g. by fitting silencers or sound proof enclosures,
- b) insulation of the operator from the noise

- source,
- c) effective maintenance of sound protection devices,
- d) indication as „ear protection areas“ where applicable,
- e) restriction of entry to these „ear protection areas“ to authorized persons,
- f) protect your hearing with appropriate personal protection measures, e.g. earplugs or hearing protectors.

## 1.6 FIRE OR EXPLOSION HAZARD

Arc welding and allied processes can cause fire and explosions. Precautions should be taken to prevent these hazards.

### 1.6.1 Fire hazard

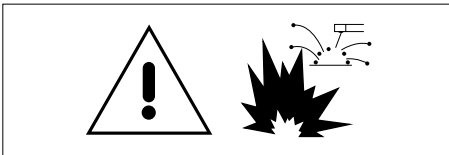

- Before setting to perform welding operations, ensure that elements involving fire hazard are removed from the zone where welding operations will take place. If it is impossible, protect all flammable elements against the impact of sparks. Remember that sparks and hot metal may penetrate through small cracks and openings into the adjacent area.
- Avoid welding in the vicinity of hydraulic conduits.
- The welding arc throws sparks and splatters out. Welders should wear clean and dry protective clothing (*staining with oil should be avoided in particular*) such as welding gloves, welder's apron, welder's trousers, welder's boots, protective hood/cap, etc.
- When welding operations are not carried out, make sure that no part of the electrode comes into contact with the workpiece or protective earthing. Accidental contact may lead to overheating and create a fire hazard.
- The fire extinguisher should be ready for use and located in an easily accessible place.
- The surroundings of the work should be observed for an adequate period after its termination.
- „Hot spots“ and immediate surroundings should be observed until their temperature has dropped to normal.

### 1.6.2 Explosion hazard

It is forbidden to heat up, cut or weld tanks, barrels or containers that contained toxic or flammable materials. For there is an explosion hazard, even if the containers have been emptied and cleaned.

### 1.6.3 Use of cylinders with shielding gas

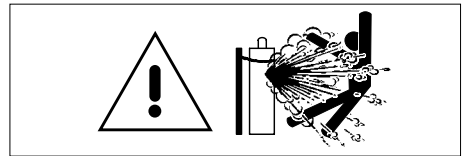

In case compressed gases are used in the work place, apply special safety measures to prevent dangerous situations.

- Use gas cylinders with appropriate shielding gas, foreseen for a particular process. Additional equipment (pressure regulator, hoses, connectors) should be in good technical condition. A gas cylinder and accessories should have the required valid attestations and approvals for use.
- Gas cylinders should always be stored in vertical position, fixed to an undercarriage or permanent support.
- Gas cylinders should be placed far away from areas, where they could be exposed to the risk of being overturned or suffering physical damage.
- Ensure gas cylinders are at a safe distance from places where electric welding or cutting operations are to be performed, away from other sources of heat, sparks or flames.
- Care shall be taken to prevent gas cylinders in the vicinity of the workpiece becoming part of the welding circuit.
- Never allow the electrode, electrode holder or any other live electric part to get in contact with the gas cylinder.
- Keep your face and head away from the

cylinder valve socket when the valve is being opened.

- Special valve shield should always be installed during cylinder transportation or when the cylinder is not used.

**1.7 OTHER HAZARDS**

Arc welding and allied processes carrying other hazards not listed before.

**1.7.1 Burns**

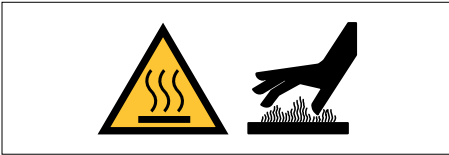

- Never touch hot parts with bare hands.
- Before handling an element, wait until it cools down.
- Use appropriate tools to grip and handle hot elements and wear special welding gloves and clothing that protects against burns.

**1.7.2 Plasma arc is dangerous**

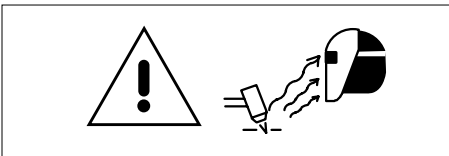

Highly concentrated plasma arc poses a hazard for health and life. It is forbidden to aim plasma arc at people.

**1.7.3 Welding wire can cause injuries**



Accidental pressing of the button on the welding torch can cause welding wire to advance in an uncontrolled manner. The welding wire tip may be sharp.

Never aim the burner tip of the welding torch at your face, eyes or other people.

**1.7.4 Moving elements can be dangerous**

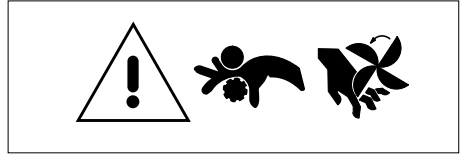

All protective elements and device housing should be in place and in good technical condition. Keep your hands, hair, clothes and tools away from gear wheels, fans and other moving parts during their operation.

Do not bring your hands close to fan motors. It is forbidden to stop a fan by pressing its axis.

**1.7.5 HF – high frequency ignition may cause interference**



As welding by the TIG method or plasma cutting involves high frequency ignition, it can interfere with mobile phones, radio equipment, TV equipment or improperly protected computers and industrial robots, which leads to total disabling of such devices.

**1.8 OTHER INFORMATIONS**

When performing welding work, you must apply equally to the health and safety requirements contained in the current normative acts, applicable in your country.



## 1.9 EXTRA PRECAUTIONS

### 1.9.1 Potential risk during plasma cutting

- during the plasma cutting – plasma arc temperature exceeds several thousand °C,
- large light radiation is accompanied when plasma cutting as a result of burning gases and the igniting of a plasma arc,
- during the perforating and the plasma cutting may occurs molten metal splashes,
- during the plasma cutting gases and fumes may occur intensively.

### 1.9.2. Risk of high temperature

Sources of heat accompanying to a process of plasma cutting come from:

- plasma arc,
- high-temperature of the burner,
- hot metal elements,
- sparks and metal spatters,
- liquid metal drops.

The effects of high temperature that may occur:

- superficial burns – total destruction of the epidermis,
- deep burns – the destruction of parts of the skin with sebaceous glands,
- full burns – total destruction of the skin.

The methods of protection against the described threats that must be taken:

- use the protective flame-resistant clothing such as: gloves, leather apron, protective footwear and headgear to protect face and eyes,
- protect operators eyes through the use of special goggles with shade of DIN 6.

## 1.10 SYMBOLS USED IN INSTRUCTIONS



We use this symbol to pay your attention about important information.

## 2. ELECTROMAGNETIC FIELDS (EMF)

Electric current flowing through any conductor causes localized electric and magnetic fields (EMF). All welders should use the following procedures in order to minimize the risk associated with exposure to EMF from the welding circuit:

- Route the welding cables together – secure them with tape when possible.
- Place your torso and head as far away as possible from the welding circuit
- Never coil welding cables around your body.
- Do not place your body between welding cables. Keep both welding cables on the same side of your body.
- Connect the return cable to the workpiece as close as possible to the area being welded.
- It is forbidden to sit or lean on power source while working.
- Do not weld whilst carrying the welding power source or wire feeder.



### WARNING!

*The electromagnetic field (EMF) generated during welding (and allied processes) may interfere with the operation of implanted medical devices for example: cardiac pacemakers. Persons with implanted medical devices such as cardiac pacemakers are obliged to consult a doctor before starting to weld/plasma cutting and to exercise special caution during work. It is forbidden for such persons to be present in the vicinity of the place where welding/plasma cutting processes are realized without previous consultation of a doctor.*

### 3. ELECTROMAGNETIC COMPATIBILITY (EMC)

#### **WARNING!**

*This Class A equipment is not intended for use in residential locations where the electrical power is provided by the public low-voltage supply system. There can be potential difficulties in ensuring electromagnetic compatibility in those locations due to conducted as well radiated radio-frequency disturbances.*

#### 3.1 GENERAL INFORMATIONS

The user is responsible for installing and using the arc welding equipment according to the manufacturer's instructions. If electromagnetic disturbances are detected, then it shall be the responsibility of the user of the arc welding equipment to resolve the situation with the technical assistance of the manufacturer. In some cases this remedial action may be as simple as earthing the welding circuit. In other cases, it could involve constructing an electromagnetic screen enclosing the welding power source and the work complete with associated input filters. In all cases electromagnetic disturbances shall be reduced to the point where they are no longer troublesome.

*Welding and plasma cutting processes may emit additional interferences. User is responsibility for the interferences caused by welding and plasma cutting.*

#### 3.2 ASSESSMENT OF AREA

Before installing arc welding equipment, the user shall make an assessment of potential electromagnetic interferences in the surrounding area. The following shall be taken into account:

- a) other supply cables, control cables, signaling and telephone cables, above, below and adjacent to the arc welding equipment,
- b) radio and television transmitters and receivers,
- c) computer and other control equipment,
- d) safety critical equipment, for example guarding of industrial equipment,
- e) the health of the people around, for example the use of pacemakers and hearing aids,
- f) equipment used for calibration or measurement,
- g) the immunity of other equipment in the environment. The user shall ensure that other equipment being used in the environment is compatible. This may require additional protection measures.
- h) the time of day that welding or other activities are to be carried out.

The size of the surrounding area to be considered will depend on the structure of the building and other activities that are taking place. The surrounding area may extend beyond the boundaries of the premises.

#### 3.3 METHODS OF REDUCING EMISSIONS

Methods of reducing electromagnetic interference are listed in detail in the standard EN 60974-9 „Arc welding equipment – Part 9: Installation and use“.

### 4. CONFORMITY WITH STANDARDS

The SPARTUS® ProCUT 45PFC plasma cutter is in conformity with the relevant Union harmonization legislation:

**LVD 2014/35/UE**

**Low Voltage Directive**

**EMC 2014/30/UE**

**Electromagnetic Compatibility Directive**

harmonized standards:

- EN 60974-1**      **Arc Welding Equipment – Part 1: Welding Power Sources**  
**EN 60974-10**    **Arc Welding Equipment – Part 10: Electromagnetic Compatibility Requirements**

#### 4.1 CE MARKING

CE marking is placed on the nameplate of device and/or on the front panel of device.



#### 4.2 RATING PLATE

Rating plate and serial number are located on the bottom of the device case.

## 5. GENERAL DESCRIPTION

### SPARTUS® ProCUT 45PFC

It is an inverter plasma cutter with integrated CNC control socket. Designed for cutting metals and other electrically conductive materials. It is powered with one-phase 230V source power.

Through the use of modern technology, we have obtained excellent source with maximum cutting current 40A. The maximum thickness of cut material is 20mm.

Built-in system of contactless pilot arc ignition without HF – provides excellent quality of cutting edge and longer life of consumables.

The easy-to-use panel with an LCD display allows for smooth adjustment of the cutting current and setting the appropriate pressure. In addition, the cutter is equipped with a 2T / 4T mode selector switch.

SPARTUS® ProCUT 45PFC is professional plasma cutter that will find application in manufacturing sectors, industry and as source of CNC plasma tables.

#### 5.1 PURPOSE OF USE

SPARTUS® ProCUT 45PFC plasma cutters is designed for thermal cutting (*plasma cutting*) steels and any other nonferrous metal and other electrically conductive materials.

## 6. TECHNICAL SPECIFICATIONS

### 6.1 OPERATION, STORAGE AND TRANSPORT

#### Conditions during operation, storage and transport

Range of ambient air temperature during operation	-10°C to +40°C
Relative humidity of the air	up to 50% at +40°C up to 90% at +20°C
Ambient air	free from abnormal amounts of dust, acids, corrosive substances etc. other than those generated by the welding process
Base of the welding power source inclined	no more than 10°
Range of ambient air temperature during storage and transport	-20°C to +55°C

**Duty cycle (def.)**

Duty cycle is the time during which You can weld or cut at a certain load without causing overload. It is expressed in percent for period of complete cycle which equals 10 minutes. For example: 60% duty cycle means that for 6 minutes device can operate at given load, after that required 4 minutes time break (no-load operation). Duty cycle is given to ambient temperature of 40°C.

**Protection against overheating (def.)**

Security system from overheating will turn on when the device is over-heat (possibility of work is turned off, abnormal indicator on front panel lights up). In such a situation, You should not turning off the unit immediately. Wait some time until fan cools the unit. Time to return to the state from overheating can take up to approx. 15 minutes.



The device has a degree of protection IP21S. Which means that it is intended to be used in closed and covered areas and suitable for use outdoors. However it is not designed to be used outdoor during precipitation if it is not covered.

**6.2 TECHNICAL PARAMETERS****ProCUT 45PFC**

Input	~1 x 230V ±10% 50/60 Hz
Cutting current[A]	20 – 40
Max. cutting thickness [mm]	20
Duty cycle [%]	60
Output working voltage [V]	18
Recomended work pressure [bar]	5
Recomended compressor efficiency [l/min]	150
Post gas	✓
Contactless pilot arc ignition (no HF)	✓
2T / 4T	✓
Current consumpion [A]	19.7
Power factor [cosφ]	0.7
Insulation class	H
Protection class	IP21S
Weight [kg]	14
Dimensions [mm]	600 × 215 × 405

**7. INSTALLATION AND USE****WARNING!**

SPARTUS® ProCUT 45PFC machine is intended for professional and industrial applications. Installation and use of the device may only be carried out appropriately trained professionals.

**Qualified person (def.)**

A person who has gained the relevant technical education, training took place and / or gained experience to perceive the risk and avoid hazards during use of the product (IEC 60204-1).

### 7.1 PROPER COOLING

The unit should be placed stable on a dry and flat surface. Avoid too much slope and slippery surfaces. Check regularly that the vents (inlet, outlet) are not covered. The minimum distance between the machine vents and walls should be 50 [cm].

### 7.2 MOVEMENT AND HANDLING

Please take special care when moving the machine. It should be moved by using of specially installed transport handle.

If transport handle are damaged, then it needs to be repaired at an authorized service center.

### 7.3 DESCRIPTION OF CONSTRUCTION

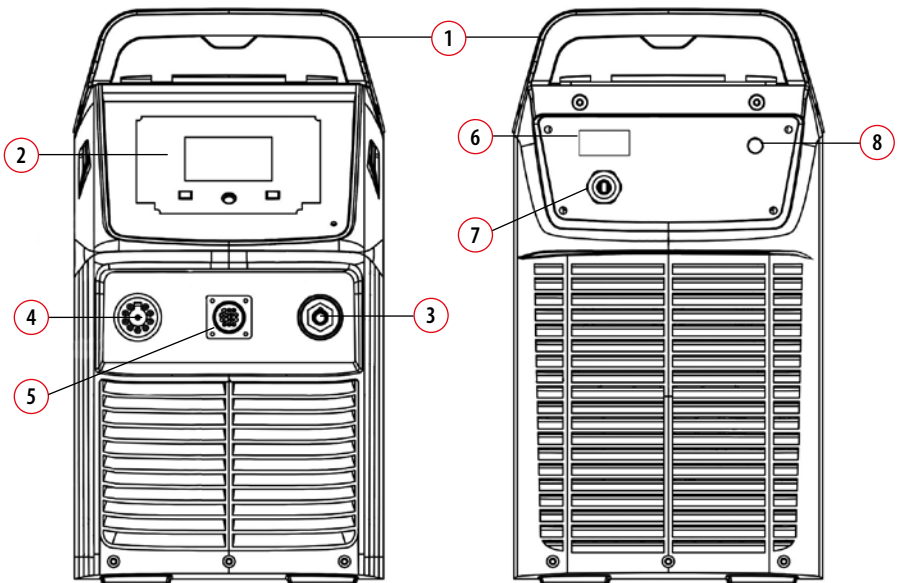

- ① Transport handle
- ② Control panel
- ③ Socket SK<sub>r</sub>+”
- ④ Plasma torch socket („-“)

- ⑤ CNC socket
- ⑥ Toggle switch ON/OFF
- ⑦ Power cable
- ⑧ Compressed air inlet

## 7.4 CONNECTING TO POWER SUPPLY

Requirements for power network parameters (voltage, permissible range of mains voltage fluctuations etc.) are given in the table with technical parameters of device and on the rating plate of cutter.

### Before connecting the unit to the power source:

- Check whether the parameters comply with the requirements for unit.
- Check: mechanical condition of the power cord and plug. The connection status of the power cord with plug and unit (loose not allowed). If the power cord or plug is damaged or loose connection is between them, it is forbidden to connect the cutter until fault has been rectified.
- The cutter machine can be connected to the network only when the power socket is properly grounded.

## 7.5 CONNECTION OF THE DEVICE



Before connecting the equipment and compressed air to the device, make sure that the unit is disconnected from the source power and the power switch **6** is in the OFF position.

### 7.5.1 Connecting the plasma torch

1. Before connecting the plasma torch, make sure that the control pins in the plug are connected like in scheme (see 7.7).
2. Connect the plug into central socket **4** with due care and caution. Pay particular attention to the fitting of control pins.
3. Secure the connection by tightening the lock nut. Check if the connection is tight.

### 7.5.2 Assembly and connection the compressed air



The compressed air or nitrogen which are used for plasma cutting should be free of contaminants such as particles, oil and or excessive moisture. For this purpose must be used special compressed air preparation elements such as: water separator, water filter, solid particles filter, oil filter, oil mist filter, etc.



Use the proper pressure reducer which allows reduction of input pressure to the limit value. To an appropriate working pressure.

1. Make sure that the air filtering block is installed properly.
2. Check the pressure coming out of the compressor or installation. Remember that the pressure cannot be greater than 3.5 – 5bar - the maximum permissible inlet pressure to the filter block and to the device.
3. Connect properly the air hose to the input terminal **8** (see 7.3).
4. Make sure that there are no leaks.
5. The working pressure is adjusted with the device turned on.
6. The value of working pressure should correspond to the values recommended (see 6.2).

### 7.5.3 Device connection

1. Connect properly plasma torch into socket (see 7.5.1).
2. Connect the compressed air into device (see 7.5.2).
3. Connect return cable into SK socket „+“ **3**.
4. Connect the plasma cutter into power supply (see 7.4).
5. Turn on the unit by setting power switch **6** in the ON position.
6. Device is ready to cut.

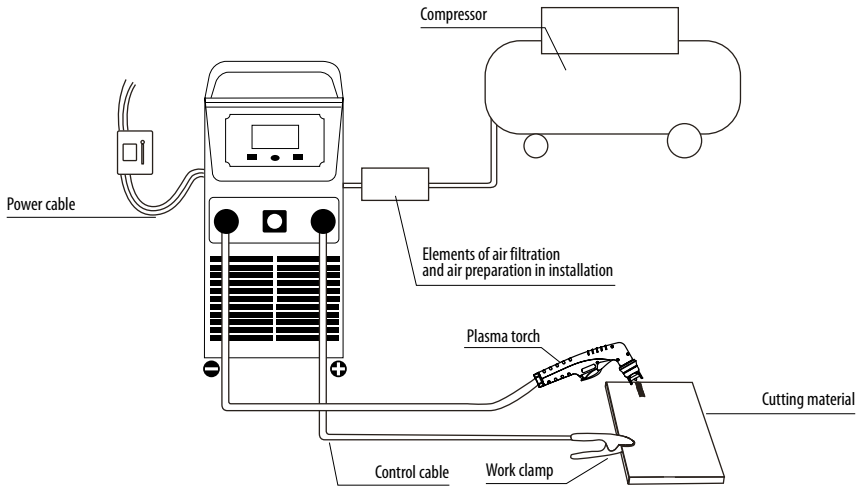

## 7.6 CONTROL PANEL



- |   |                     |   |                      |
|---|---------------------|---|----------------------|
| ① | Screen              | ③ | Cutting current knob |
| ② | Mode switch 2T / 4T | ④ | Air check key        |

### 7.6.1 Description of parameters on the display

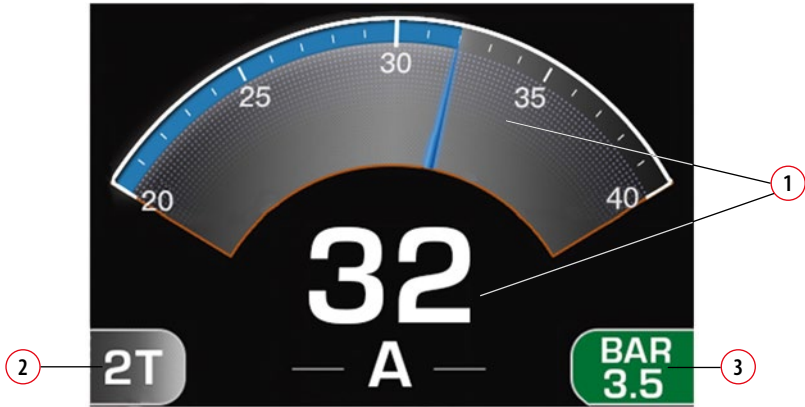

- ① Current display
- ② Operating mode 2T / 4T
- ③ Air check display

#### 2T / 4T mode



To start cutting press the microswitch, to start the plasma arc. Releasing the microswitch will stop the cutting process.

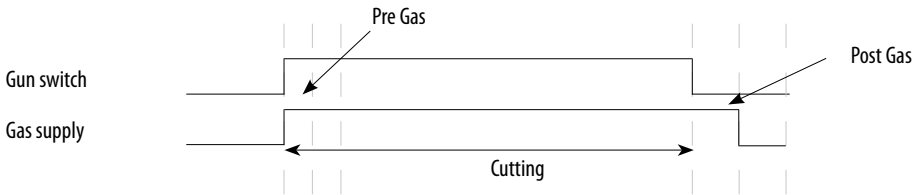

To start cutting, press and release the microswitch. The cutting process will stop after pressing and releasing the microswitch again.

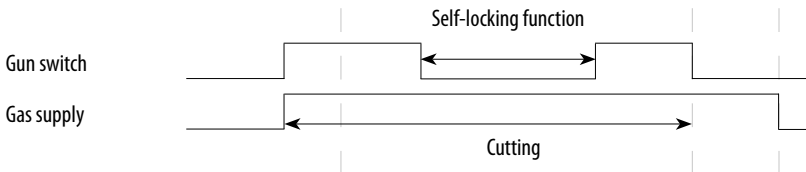



### AIR CHECK DISPLAY

Press the air check key „PRESSURE“ to check whether the air passage is smooth. If the machine is working properly, the screen will display the air pressure value normally.



E12 „Lack of gas“ message informs about the lack of air flow.



### OTHER MESSAGES

„E01 Overheat“ message – information about overheating. The alarm will release after the period of fan cooling. You can restart the machine.



### 7.7 CENTRAL CONNECTOR – SETUP OF PINS

The device and plasma torch are equipped with central connector.

- |   |               |
|---|---------------|
| 1 | Start – Stop  |
| 2 |               |
| 5 | Pilot arc     |
| 6 |               |
| 8 | Shield nozzle |
| 9 |               |

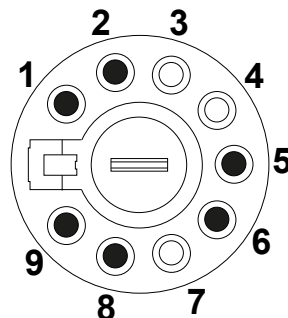

## 7.8 CNC CONNECTOR

ProCUT 45PFC plasma cutter is designed to work as a plasma source in cooperation with CNC tables. Communication between CNC table and plasma cutter is performed by using a special CNC control socket.

Diagram how to connect CNC control socket.

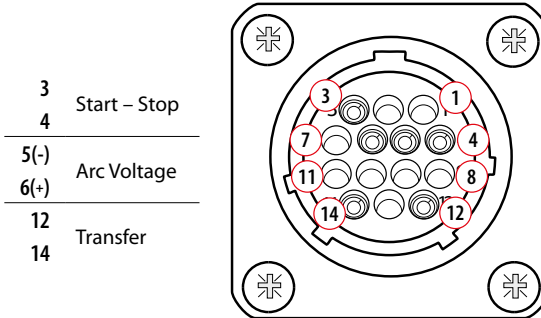

## 7.9 THE PROCESS OF CUTTING

SPARTUS® ProCUT 45PFC is equipped in standard with system of contactless arc ignition with HF – high-frequency generator. There is no need for the nozzle tip to contact the surface to ignite the plasma arc.

For manual plasma cutting, use a special spacers, included to the plasma torch. It is important to puncture properly through the material and guide the plasma burner at a right speed to maintain the proper penetration through material.

You should replace nozzles or electrodes for a new one in the following cases:

- when the nozzle head (*the hole in the nozzle*) is deformed, discalibrated,
- when electrode has cavities above 1mm,
- during the cutting plasma arc appear green flames,
- cutting gap is inclined or too wide,
- the arc flame is diffuse (*is not condensed*).

## 7.10 THE TABLE BELOW FOR THE SHIFT AND SCALE SELECTION

The factory presets the voltage divider to 20:1. To change the voltage divider to a different setting:

1. Turn OFF the power supply and disconnect the power cord.
2. Remove the power supply cover.
3. Locate the voltage divider DIP switches on the left side of the power supply.

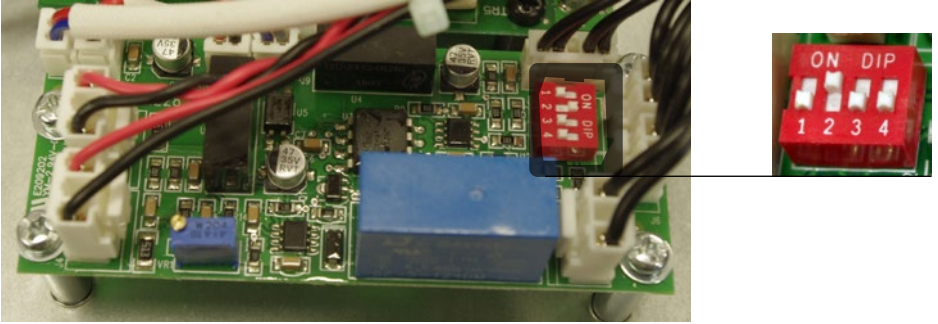

VOLTAGE DIVIDER		Scale selection			
		20:1	30:1	40:1	50:1
Number	1	ON	1	1	1
	2	2	ON	2	2
	3	3	3	ON	3
	4	4	4	4	ON

### 7.11 RECOMMENDED SPARTUS® SP45H PLASMA TORCH (standard TRAFIMET® S45)

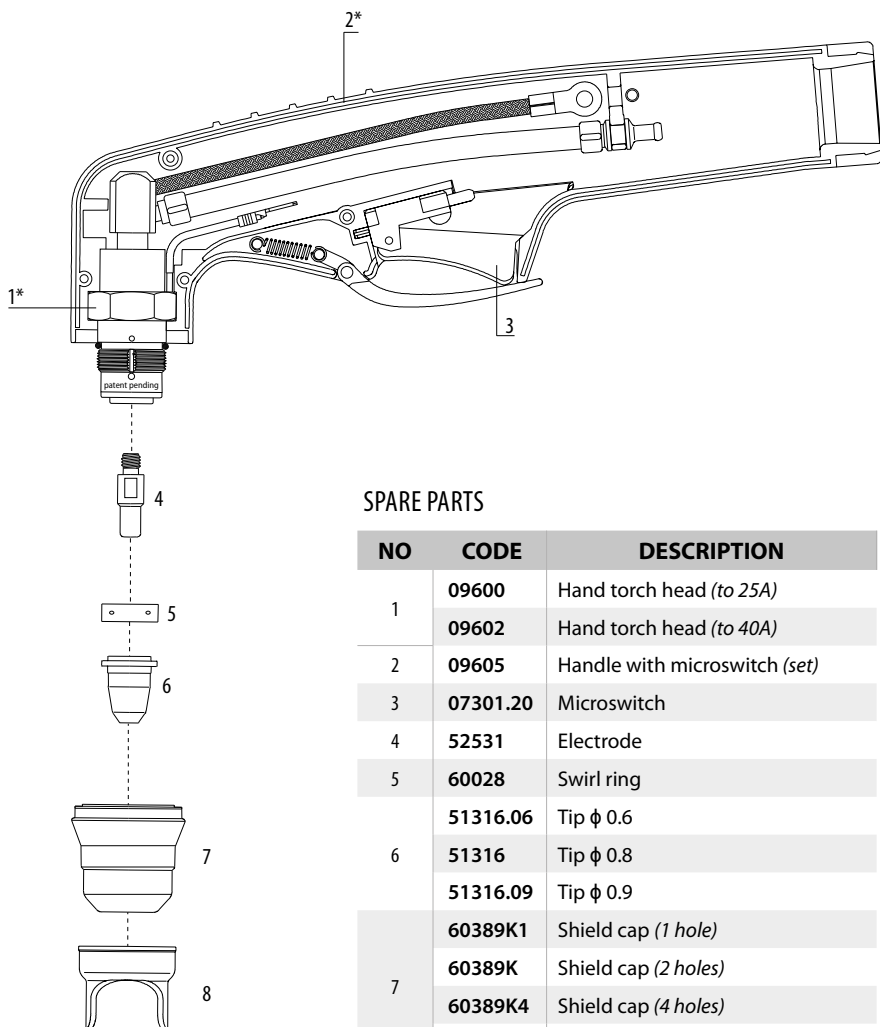

#### SPARE PARTS

NO	CODE	DESCRIPTION
1	09600	Hand torch head (to 25A)
	09602	Hand torch head (to 40A)
2	09605	Handle with microswitch (set)
3	07301.20	Microswitch
4	52531	Electrode
5	60028	Swirl ring
	51316.06	Tip $\phi$ 0.6
	51316.09	Tip $\phi$ 0.9
6	51316	Tip $\phi$ 0.8
	60389K1	Shield cap (1 hole)
	60389K	Shield cap (2 holes)
	60389K4	Shield cap (4 holes)
7	60389	Shield cap (6 holes)
	60431	Double pointed spacer

## 8. MAINTENANCE



### WARNING!

*Before performing any maintenance or repairing of device, it should be disconnect from the power source and wait at least 5 minutes. The voltage accumulated in capacitors should be discharged at this time to a safe level. But even after that operation you should be careful.*



*Maintenance and repair work may be performed only by qualified personnel with the appropriate permissions. Regular maintenance provides adequate service life and trouble-free operation of the device.*

### Daily (before each use/installation):

- Perform a visual inspection of the housing, knobs, control panel.
- Inspect (visual inspection) the power cord and power plug. Check the insulation of the cable.
- Check the condition of cables and their connectors. If cable insulation is damaged – replace it. If connection is not tight – press the plug.
- Check if the cooling fan is working properly.
- Make sure that all vents are not obstructed.
- Check the elements blocking air preparation. If necessary, drain excess condensate from the filters.
- Check the technical condition of the plasma torch and consumables.

### At least once a month:

- Regularly remove dust from inside the machine using compressed air. The pressure should be low enough so as not to damage small parts inside the device. If the dust level is high in the workplace, clean the machine more often.
- Check the connection of internal electrical components. If anywhere the joints are not tight – tighten them.

### Once a year:

- You should send device to an authorized service center for an interim review.

## 9. ENVIRONMENTAL PROTECTION

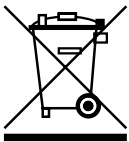

The product must not be disposed of into an ordinary waste container. It is totally forbidden to dispose of electric or electronic equipment marked with a crossed-out trash can symbol by throwing it into ordinary waste containers. According to the WEEE directive (directive 2012/19/UE), binding within the European Union, such products should be disposed of according to local regulations.

We hereby inform the client that, according to the regulations, each commodity is burdened with waste disposal costs (WDC) according to charging rates valid for a given year.

**Attention!** If using liquid to water-cooled torches, utilize it according to attached information.

## 10. TROUBLESHOOTING



Not all problems with functioning of the device, are the evidence of failure. You can independently carry out an analysis in search of probable failure. In case of doubt, please contact to SPARTUS® dealer or authorized service center.



During the warranty period all repairs should be carried by authorized service center. Repairs carried out by unauthorized persons will void the warranty.

### PROBLEMS AFTER TURNING THE DEVICE ON

After turning on the unit the fan is not working. The unit does not cut.	Absent phases. The main board in the machine is break.
After turning on the device on the display „Lack of gas“ message appears.	No air flow or pressure is too low.
After turning on the device on the display „Overheat“ message appears.	Air flow or fan is blocked. The machine is over-heat. Input voltage over the normal range.

### PROBLEMS WITH PLASMA ARC

The plasma arc does not appear when the micro switch is pressed.	The shield cup is unfitted installation. The Tip or electrode is unfitted installation. Gas pressure is too high or too low.
The plasma arc does not change into cutting.	It is inaccurate connection between torch and power supply. Work cable not connected to work piece.
Arc shuts off during operation, and it will not restart.	Power supply is overheated. Gas pressure too low. Torch consumables worn.

### CUTTING PROBLEMS

No gas flow – the screen is on and fan operates.	Gas pipe not connected or pressure is too low.
Low cutting output.	Incorrect setting of cutting current. Current control set is too low.
The cutting quality is poor.	The torch move too fast across the workpiece. Excessive oil or moisture in torch. Air pressure is too low.



**EASY**

*Simple solutions and an attractive price – these are the features of SPARTUS® Easy series devices. Our equipment has been designed with ease of use and ergonomics at work in mind.*

*A masterly combination of high quality production, excellent parameters and ergonomics – these are features of the SPARTUS® Master series of devices, which were created with demanding welding jobs in mind.*



**MASTER**



**PRO**

*Precision, functionality, excellent parameters and resistance to high workloads – these are the features of the SPARTUS® Pro industrial series of devices. This series consists of specialised solutions which will satisfy even the most demanding users.*



Videopresentation of products



Subscribe to the channel [SPARTUS.INFO](https://www.youtube.com/channel/UCSPARTUS)